

SECURPULLEY®

by TORNOMECCANICA s.r.l.

**PULLEY WITH SAFETY BRAKE
FOR THE BUILDING INDUSTRY**



OPERATING AND MAINTENANCE INSTRUCTIONS

TORNOMECCANICA s.r.l.

Genova • Via Renata Bianchi 67N

Tel: 010 650 94 04

Telefax: 010 650 94 05



**SHEAVE FOR BUILDING INDUSTRY
WITH SAFETY BRAKE**

MODEL: SECURPULLEY®

SAFE WORKING LOAD:50 KG

TORNOMECCANICA 99112036.1-2309

INDEX

1. PURPOSE OF THE INSTRUCTION MANUAL	pag. 1
2. SPECIFICATIONS:	1
3. FORESEEN USE AND SAFE USE OF THE SHEAVE	
3.1 Generals	2
3.2 General directions for the safe use	2
4. DESCRIPTION AND FUNCTIONING OF THE SHEAVE	
4.1 Description	3-4
4.2 Functioning	5-6
5. INSTRUCTIONS OF INSTALLATION AT THE WORKING PLACE	7-8
6. INSTRUCTIONS FOR USE	
6.1 Generals	9
6.2 Insertion of the rope into the sheave	10
6.3 Regulation of the counterweight according to the lifting height	11
6.4 Check of the wedge-pressing bush for adapting to the rope diameter	12
6.5 Functional test before use	13
6.6 Lifting of loads (building of scaffolds)	14-15
6.7 Descent to ground of the empty rope	16
6.8 Lifting of the empty rope to the floor (scaffolds dismantling)	17
6.9 Lowering of loads	17
7. TROUBLE SHOOTING	18
8. INSTRUCTIONS FOR MAINTENANCE AND PERIODICAL CHECK	
8.1 Generals	19
8.2 Periodical check and maintenance	20
8.3 Substitution of parts	21
• 8.3.1 Substitution of the wedge- brake	21
• 8.3.2 Substitution of the rope reeving roller	21
• 8.3.3 Substitution of the spacers counterweight side and reeving roller side	21
• 8.3.4 Substitution of shaft and knobs of the counterweight	21
9. SPARE PARTS	22
10. WARRANTY	22

Graphic symbols used in the manual:

 = *important remark: consider carefully*

 = *warning of possible danger*

1. PURPOSE OF THE INSTRUCTION MANUAL

These instructions are done in conformity with the requirements of the Machinery Directive (89/392 CEE) para. 1.7.4, 4.4.2 - Enclosure 1. They give the directions for the correct and safe execution of:

- *installation at the working place*
- *use*
- *maintenance and periodical check*

It is very important that the instructions are available to the personnel charged with the said operations, and clearly understood by it, before the execution of the operations themselves.

The manual is integral part of the supply of the machine and must be kept with care and kept at the users' disposal.

In case of incomprehension of the explanations of the manual, of malfunctioning or for repair interventions that do not belong to the foreseen maintenance, please contact our After Sale Service.

2. SPECIFICATIONS:

WEIGHT:	kg	5
MAXIMUM WORKING LOAD:	kg	50
MINIMUM WORKING LOAD:	kg	8÷10
MAXIMUM SUGGESTED WORKING HEIGHT:	m	30
MAXIMUM WORKING HEIGHT:	m	40
ROPE DIAMETERS TO BE USED:	mm	18
	mm	20
SUPPORTING ON STANDARD SCAFFOLDING PIPE		
EXTERNAL DIAMETER:	mm	48

 **FOR THE GOOD RUNNING AND THE SAFETY OF "SECURPULLEY®"**
WE SUGGEST TO USE OUR FAST RELEASE SUPPORT (O SYSTEM).

3. FORESEEN USE AND SAFE USE OF THE SHEAVE

















3.1 Generals

For using the sheave without dangers it is necessary to follow the instructions contained in this manual.

The sheave SECURPULLEY® is foreseen for manual lifting and lowering of loads during building and dismantling of scaffoldings.

SECURPULLEY® introduces in this working ambient a new and basic safety concept: the warranty of an automatic braking of the load as the human effort on the rope ceases.

3.2 General directions for the safe use

-  Do not install and use the sheave in a different way from this manual indicates. The manufacturer does not respond for any damage due to improper use or neglecting the safety measures.
-   The working area must respond to the safety requirements foreseen by the law. ***In particular it is forbidden to stay below the suspended loads.***
-   Do not use the sheave for lifting heights or loads exceeding the values indicated at chapter 2.
-   Do not use ropes of diameters different from the ones indicated at chapter 2.
-   Do not use ropes with the diameter reduced by wear below the minimum diameter indicated at chapter 2, nor with strands deformed o damaged. ***The malfunctioning of the sheave and the possible troubles coming out from the use of a damaged rope are under the only responsibility of the user.***
-   Before starting the use of the sheave, check the correct positioning of the setting counterweight related to the working height and rope weight, and test the braking efficiency
-   For the use of SECURPULLEY® always wear safety gloves and shoes, beyond to other safety individual protection means if any, foreseen by the safety plan of the yard.
-  Store the sheave in a dry and clean ambient; after the use in presence of powder, clean the sheave, preferably by a compressed air stream.
-   Do not eliminate, nor substitute with not original spare parts any component of the sheave, not to risk compromising its safety features.

Detailed safety directions for installation, use and maintenance are given in chapters 5, 6, 7, 8.

4. DESCRIPTION AND FUNCTIONING OF THE SHEAVE

4.1 Description

The sheave SECURPULLEY, is a Tornomeccanica patent: it is marked with the CE mark in conformity with the Machinery Directive on the safety of the machinery and is supplied with the CE Conformity Declaration.

Overload static tests with 400% of rated load have been successfully done on one prototype.

Each unit is tested with 150% overload.

These tests conform to the standard prEN 13157

Figure 1: SECURPULLEY assembly

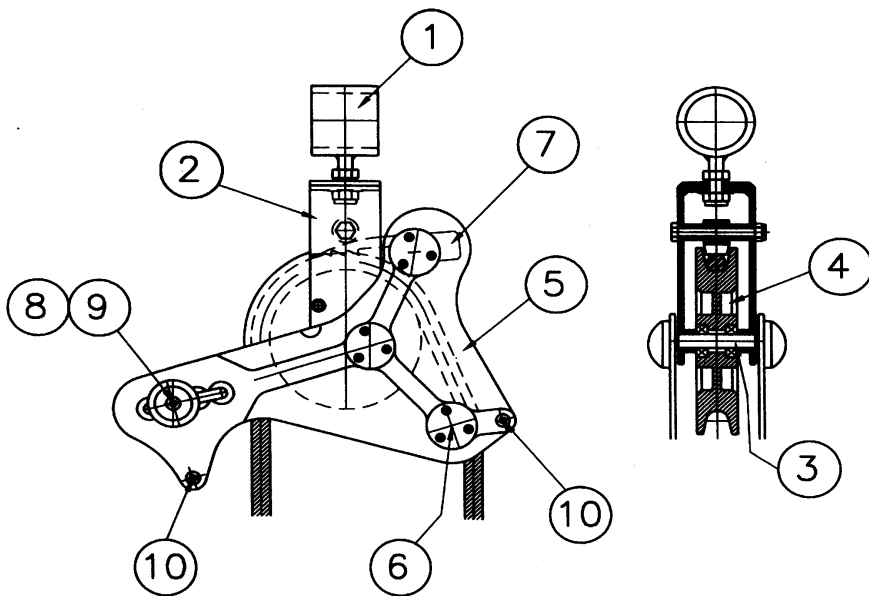

Legenda:

1. Rotating sleeve
2. Supporting bracket
3. Sheave axle
4. Sheave
5. Side plates
6. Reeving roller
7. Wedge-brake
8. balancing counterweight
9. counterweight unlocking screws
10. spacers counterweight side and reeving roller side

The rotating sleeve **1** allows to safely fix the sheave to the supporting point and allows its oscillation in a vertical plane.

The bracket **2** is slewing relative to the sleeve **1**, so that the whole body of the sheave assembly can rotate in comparison with such support.

The bracket **2** houses the axle **3** on which the sheave **4** is arranged, through small rollers bearings.

The two side plates **5** are fixed to the bracket **2** and are rotating around an axle eccentric relative to the sheave axle.

In turns, the two side plates bears the reeving roller **6**, the floating wedge-brake **7** and the balancing counterweight **8**.

La counterweight **8** position setting is done by the loosening of the screws **9** which requires, for safety reasons, of a special key supplied with the sheave.

The spacer located on the "fore" part of SECURPULLEY®, allows unlocking the brake, operating the rope from the height for the descent at no load.

The spacer located on the "rear" part of SECURPULLEY®, has an anti-spooling function for the rope.

4.2 FUNCTIONING

- ☞ For the use of SECURPULLEY® two operators must always be employed: one at ground and one at the working level

The load to be handled must be connected to the rope on the side where the counterweight is arranged

The manoeuvring rope is thus the one on the opposite side (see Figure)

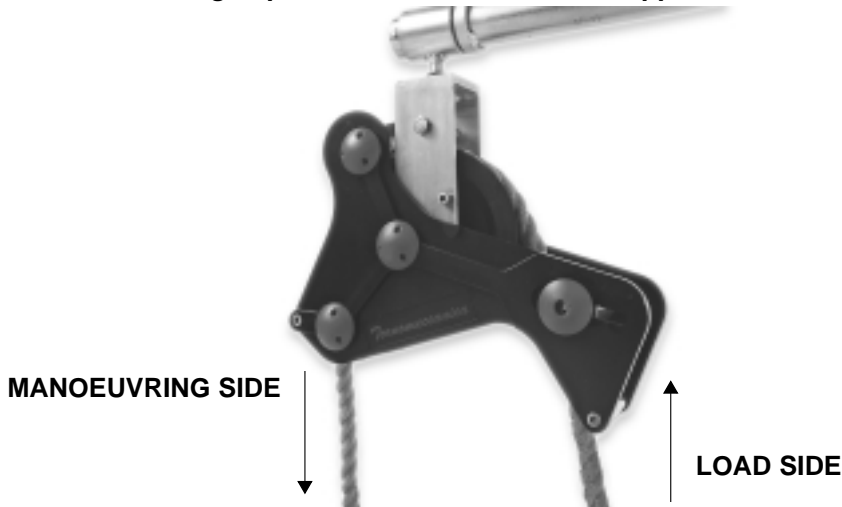

Figure 1a: position of manoeuvre and hoisting rope falls

The force exerted by the operator on the rope for hoisting or retaining the load involves a push on the reeving roller 6 that in turns involves a rotation of the side plates and the opening of the brake.

Closing of the brake: the wedge-brake is in contact, with its upper surface, with a bush, assembled on an axle, which involves the self-locking action of the lower part of the wedge onto the rope.

This happens whenever the operator's force on the rope ceases and the two side plate rotate, putting the wedge in contact, at one side with the bush and at the opposite side with the rope.

Two bushes are supplied, having different dimensions, suitable, respectively for 18 mm dia and 20 mm dia ropes.

The settable counterweight **8** has the function of adapt the sheave configuration to the various heights, through a compensation of the rope weight, which changes a function of its length.

Thanks to this regulation the braking action can always be set to the best conditions that means to be as quick as possible in case of load fall, thus preventing dangerous ways in free motion that involve a reduced safety and excessive dynamic efforts on the assembly at the braking phase.

N° 4 regulation positions are foreseen for the counterweight, related to the working height and to the rope diameter.

The table shows the suggested settings for the counterweight, according to the tests results.

-  The specified conditions could not be the best ones when operating with wet rope, or with a rope having different density: always proceed to a functional test before the use.

INDICATIVE TABLE FOR THE SETTING OF THE COUNTERWEIGHT

HEIGHT (m)	COUNTERWEIGHT POSITION	
	ROPE DIA 18	ROPE DIA 20
Up to 10	1	1
from 10 to 20	1,2	2,3
from 20 to 30	2,3	3,4
from 30 to 40	3,4	

(*) limit conditions: operate with care

5. INSTRUCTIONS OF INSTALLATION AT THE WORKING PLACE

The support for SECURPULLEY® must be a standard pipe for scaffolds, with external diameter 48 mm.

The supporting pipe must be arranged horizontally; the supporting sleeve for SECURPULLEY® must be positioned at the free extremity of the pipe, coupled to the pipe and locked against the longitudinal movement.

N° 3 types of supports are foreseen for SECURPULLEY®, all of them made from a pipe with diameter 48 mm:

a) piece of standard scaffolds pipe: connection to the vertical pipe by a scaffolds clamp preferably of pressed type of thickness adequate to insure a good stiffness.

The sleeve for SECURPULLEY® is fixed at the extremity of the pipe and locked against the longitudinal movements by two clamps, one per side of SECURPULLEY®

b) supporting pipe for SECURPULLEY® manufactured by TORNOMECCANICA: includes a strong clamp for the connection to the scaffolding pipe, and a locking system at one extremity, for quick locking and unlocking of SECURPULLEY®.

☞ The connection of SECURPULLEY® by a cantilever pipe involves a bending stress in the clamp and in the supporting pipes: with heavy loads in free fall, the braking efforts can make such stresses become considerable.

Do not overcome the cantilever dimensions indicated by figure 2,

not to charge excessively the supports

Frequently check the tightening of the clamp screws



Fixing scheme for loads up to 30 kg

Fixing scheme for loads over 30 kg

Figure 2: cantilever support for per SECURPULLEY®

c) slewing support manufactured by TORNOMECCANICA.

The TORNOMECCANICA made slewing support, with quick slewing lock is a accessory which includes the locking device for the SECURPULLEY? sleeve (see page9): it is made from aluminium alloy, and therefore is particularly light.

The reinforced frame ensures a high rigidity under any load condition, and the connection to the scaffolding pipe in N° 2 points eliminates the bending stresses on the clamps and reduces quite a lot the efforts on them.

The slewing of the support allows to work at the working floor in an easier, qicker and safer way, because the hanging loads can be rotated from/to the working floor together with the whole support and SECURPULLEY®.

Assembling instructions:

With every type of support, before assembling the sleeve onto the pipe, clean the two mating surfaces and slightly grease the pipe, in order to prevent rusting (for steel pipes) and allow the free movement between sleeve and pipe.

☞ Assemble the support at an height of 160 - 190 cm from the working floor, for the best working conditions of the operator who must receive the loads and make the rope descent to ground.

☞ ⚠ Before starting operating with SECURPULLEY® check that the supporting pipe is correctly installed and the scaffold on which the support is fixed is strong and stiff enough.

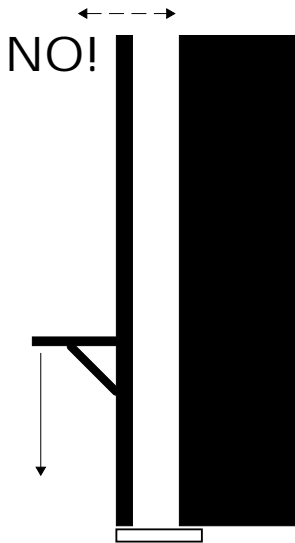

A) The pipe on which he support for SECURPULLEY is fixed, is free at the top, and can swing, causing an incorrect functioning of the sheave: incorrect arrangement

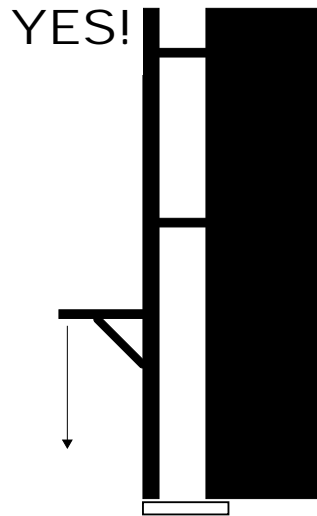







B) The pipe on which he support for SECURPULLEY is fixed, is stiffened by a correct connection to the wall and cannot swing: correct arrangement for the sheave functioning

Figure 3: scheme of correct and incorrect arrangements for the support of SECURPULLEY®

6. INSTRUCTIONS FOR USE

6.1 Generals

SECURPULLEY® has been designed with the specific purpose of eliminating the risks due to manual handling of parts of scaffolds, and moreover to allow the operators to temporary stop the lifting, for rest, or for a sudden inconvenience, leaving the load safely hanging

-  For the best and safe functioning, it is necessary that the setting of the balancing counterweight is corresponding to the actual operating conditions, as previously described.
-  Always lift loads adequate to the physical capacity of the operator, also related to the lifting height
-   Put the due attention to the fastening of the load onto the rope: ***danger of load fall***
-   For the best safety of the operator at ground, he must stand, during the loads handling, as far as possible from the vertical below the suspension point, in a compatible way with the manoeuvre angle of the rope and the available space around the scaffolding.

6.2 Insertion of the rope into the sheave

For inserting the rope into SECURPULLEY? refer to figure 4

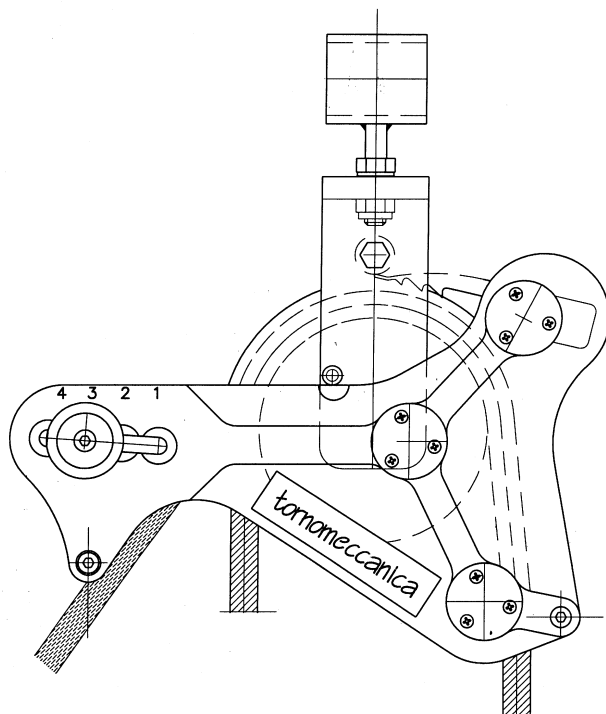

Figure 4: insertion of the rope

Make the side plates rotate such in a way to space out the brake from the sheave.

Keep the wedge lifted, pulling downwards its rear part (not serrated)

Insert the rope in the sheave, according to figure 4: the rope must pass between the pulley and the counterweight at the iload side and over the roller at the ipulling rope side.

The rope could be inserted from both sides of the sheave, but usually a knot is foreseen on it (for locking purposes during the lowering of the empty rope) on the load lifting side. In this case, the rope must be inserted from the counterweight side.

6.3 Regulation of the counterweight according to the lifting height

Before starting each working shift, it is compulsory to check the balancing of the counterweight according to the working height. Move the counterweight in the position indicated at para.4.2, and marked in the side plate of SECURPULLEY® in correspondence with the slotted housings.

To move the counterweight proceed as follows:

- Insert the plastic key with n^∞ three pins in the three holes existing in one of the two knobs located at the sides of the counterweight, at the external of the two side plates
- Keep with one hand the key and with the other hand the opposite knob
- Rotate counterclockwise until the unlocking of the counterweight is achieved, and it can slide along the side plates
- Position the counterweight in the selected position (see table at para. 4.2)
- Tighten again the counterweight in the housing, with reverse operation of before.
Do not excessively tighten the knobs!
- Pull out the key from the knob.

6.4 Check of the wedge-pressing bush for adapting to the rope diameter

SECURPULLEY® is factory assembled with a bush suitable for rope diameter 18 mm and marked with the 18 mm mark.

For use with a rope of 20 mm diameter the bush must be substituted with the other one supplied with the sheave and marked with the 20 mm mark.

For substitute the bush do as follows:

For substitute the bush do as follows:

- by two 17 mm spanners unscrew the nut from the screw that keeps the bush in place
- take off the screw and make free the bush, the bronze bush on which the bush is assembled and the two side spacers.
- insert the new wedge-pressing bush onto the bronze bush and assemble it on the screw with the two spacers.
- Pay attention to the position of the wedge that must have its flat part below the wedge-pressing bush
- Tighten the nut

6.5 Functional test before use

-  **Before starting any working shift it is compulsory to check the brake efficiency, as herein described**

After the settings described at para. 6.1.1 e 6.1.2, check the functioning as follows:

lift a little from ground a load equal to the maximum load to handle during the shift. Release the rope and check the brake closing, which must quickly stop the load.

If the braking action is not quick, check the sheave

as described in chapter 7 before start working.

Make also the following functional checks:

- **Check the free rotation of the sleeve onto the pipe**
- **Check the free rotation of the sheave**
- **Check the free rotation of the reeving roller**
- **Check the free movement of the two side plates**
- **Check the free rotation of the supporting bracket onto the sleeve**
- **Check the free rotation of the wedge-pressing bush**

The directions for the following operations are herein given:

- Lifting of loads
- Lowering of the empty rope
- Lifting of the empty rope
- Lowering of loads

6.6 Lifting of loads (building of scaffolds)

For scaffolds erection the sequence is:

loads lifting - empty rope lowering.

- ☞ Remind that SECURPULLEY® must be oriented, for a good functioning, at a right angle to the supporting pipe during lifting and lowering of loads.

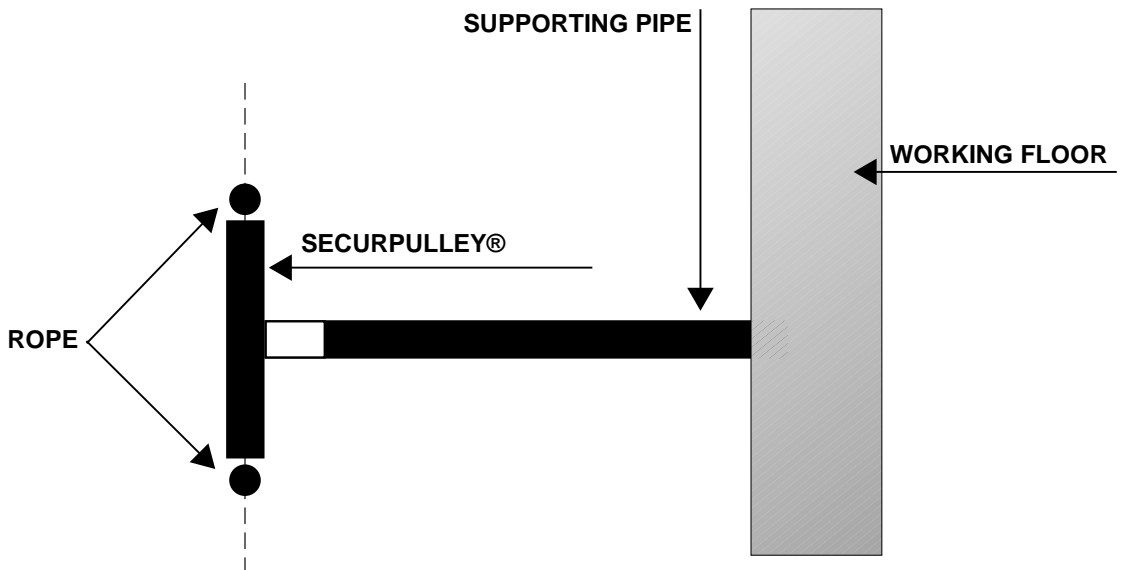

Figure 4: scheme in plant of SECURPULLEY® orienting for loads handling

After the routine checks described at para. 3.1, firmly secure the load to lift and start pulling the rope lifting the load towards the desired level.

As the force on the rope is decreased, as well suddenly released, the loads starts a small descent and immediately afterwards the brake is automatically engaged and locks the rope. The brake is operated also when the rope is taken away from the vertical, such in a way that the lifting rope becomes inclined and the action of the rope onto the reeving roller is less and less effective.

If the operator wants to stop the load for rest during the lifting stroke it is sufficient that he decreases the lifting force, until the load starts come down: after a few operations it will become easy to understand the response of SECURPULLEY® to the manoeuvres on the rope!

When the load reaches the working level, it shall be stopped with the action before described, and the operator at the floor will handle it to the floor. If you are working with a rotating support TORNOMECCANICA, the operator at the floor first unlock the rotation, than makes it rotate towards him thus taking the load towards the landing surface.

He then takes the load and pulls the rope slightly and progressively towards him, thus unlocking the brake: the loads will come down to the floor.



Pay attention not to make the load to descent suddenly: danger of feet crushing!

The operator at the floor, after having the load resting down, makes the rope becoming a little slack, unties the load and the provides the rope to go down for the next load.

6.7 Descent to ground of the empty rope

If you are working with a rotating support TORNOMECCANICA, the operator at the floor pulls it out and locks the support, in order to make easier the descent of the rope, avoiding that it can entangle.

The operator at the floor pulls the rope \bar{n} at the load (counterweight) side towards him, orienting SECURPULLEY® at an angle of about 30° with the supporting pipe.

During this pulling action, the rope comes in contact with the counterweight spacer and the brake is released. In this way the rope comes to ground. As the length and thus the weight of the rope fall going down increases, the descent of the rope becomes easier and quicker.

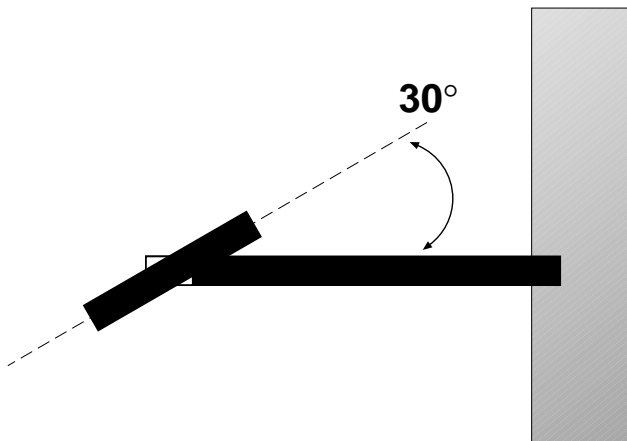

Figure 5: scheme in plant of SECURPULLEY® orienting for the descent of the empty rope.

6.8 Lifting of the empty rope to the floor (scaffolds dismantling)

For scaffolds dismantling the sequence is:
empty rope lifting ñ loads lowering.

The operator at ground pulls the empty rope, that, with its dead weight keeps the brake open.

The operator at the floor controls the rope lifting, to avoid that, over a certain height, it increases its speed and hits the SECURPULLEY® body.

To avoid damages to SECURPULLEY® in the case the rope slips, a rubber ring is supplied with SECURPULLEY®, to be assembled on the rope at the end used for the load fastening.

6.9 Lowering of loads

 ***SECURPULLEY® is gifted with a safety brake, against the loads fall, and not to be used as a friction brake: do not use the brake for slow-down of loads, or the rope and the brake itself will be damaged***

The operator at the floor fastens the load to be lowered; the operator at ground slightly pulls the rope and lifts the load. The brake will keep the load steady.
The operator at the floor in the meanwhile helps the load to be pulled out.

If you are working with a rotating support TORNOMECCANICA, the operator at the floor rotates the support outwards and locks it.

The lowering can start: the operator at ground make the load go down with a continuous control of the speed.

 ***The load must go down at a reasonable speed: an excessive speed can involve dangers for the operator himself and other people.***

In the case the rope should slip from the operator, and the load starts to go down in free motion, the safety brake immediately stops it.

7. TROUBLE SHOOTING

Herein a guide to the location and removal of some possible malfunctioning causes is given.

If the problem does not belong to the listed ones, or it is not possible to repair it with simple actions, ask for our After Sales Service.

FOUND OUT INCOVENIENCE	CHECK / REMEDY
<p>The braking of loads is not quick; the load do not stops in a short space</p>	<p>Check the correct position of the balancing counterweight</p> <p>Check that the proper wedge-brake pulling bush is assembled, related to the used rope diameter</p> <p>Check the wear of the wedge-brake; substitute it if necessary</p> <p>Check the diameter and the wear condition of the rope</p> <p>Do not operate with lifting heights exceeding the recommended ones</p>
<p>One of the rotating parts:</p> <ul style="list-style-type: none"> • Pulley • Reeving roller • Side plates • Supporting bracket • Wedge pressing bush <p>Does not move freely</p>	<p>Check that no parts or dust has entered in between the moving parts: take off anything inside and clean carefully</p> <p>check that the bearings or bushes are not locked together or damaged: substitute or ask for the substitution of damaged parts to After Sales Service</p>
<p>The whole SECURPULLEY® does not swing around the supporting pipe</p>	<p>Check that the pipe has the proper external diameter</p> <p>Check that between the SECURPULLEY® sleeve and the pipe there is no dust, rust: clean and slightly grease the surfaces</p>

8. INSTRUCTIONS FOR MAINTENANCE AND PERIODICAL CHECK

8.1 generals

A correct storage and maintenance are basic for ensuring the safety, efficiency and durability of SECURPULLEY®.

SECURPULLEY® does not require particulars maintenance interventions, except cleaning and periodical checks, besides the substitution of some wear parts.

We recommend following the directions herein given:

- Take care of cleaning SECURPULLEY®: eliminate dust or small parts with a compressed air stream or, if necessary with thin steel wires or tools. If taking off parts penetrated inside is difficult, do not use force, not to damage internal parts. If the disassembly required is not included in the ones foreseen in this chapter, ask for After Sales Service help.

- Store SECURPULLEY® in a dry place, protected from dust and polluting agents.
- Execute the periodical check indicated.
- Substitute parts worn or damaged, if any, with genuine spare parts.
- Never modify SECURPULLEY®.
- Never have SECURPULLEY® repaired by unauthorised dealers.

8.2 Periodical check and maintenance

For a good functioning of SECURPULLEY® the indicated operations must be done, as well as the daily checks described at para. 6.1

MONTHLY:

Check the wear degree of the wedge-brake: if a wear is recognised, with reduced braking action and modification of the serrated profile, the wedge-brake must be substituted.

Check the wear state of the wedge pressing bush: if the external surface is damaged, a new bush must be used.

Check the state of the pulley rim: if it is worn or damaged it must be substituted.

Check the state of the reeving roller: if its surface is worn or damaged it must be substituted.

THREE-MONTHLY:

Check the state of the bearings: make rotate the pulley, the supporting bracket, the reeving roller.

Check that the rotation is free, without visible gaps or vibration.

If a bearing is damaged, it must be substituted.

8.3 Substitution of parts

Per la sostituzione delle parti non indicate nei paragrafi seguenti, rivolgersi a Tornomeccanica o ad un rivenditore autorizzato.

8.3.1 Substitution of the wedge- brake

- unscrew the screws that keep in position the red plastic repairs positioned over the wedge axle
- by two 17 mm wrenches unscrew the nut from the screw that keeps the wedge in position
- take off the screw and clear the wedge, the bush onto it is assembled and the two lateral spacers
- insert the new wedge on the bush and assemble it onto the screw with the two spacers
- pay attention to the position of the wedge, that must be positioned below the pressing bush
- fasten the nut
- re-assemble the red repairs

8.3.2 substitution of the rope reeving roller

The reeving roller is supplied as a spare part complete with bearing, spacer, screw, and nut.

- unscrew the screws that keep in position the red plastic repairs positioned over the roller axle
- by two 17 mm wrenches unscrew the nut from the screw that keeps the roller in position
- take out the screw and clear the roller
- substitute the roller, assemble in its position and fasten the nut.
- re-assemble the red repairs

8.3.3 Substitution of the spacers counterweight side and reeving roller side

- By two 6 mm wrenches unscrew the screws that keeps the spacer in position. Beware!

The spacer counterweight side is assembled onto a shaft and can rotate.

The spacer reeving roller side is fixed

8.3.4 Substitution of shaft and knobs of the counterweight

- Insert the red plastic key with the three pins into the counterweight knob
- Insert at the centre of the opposite knob a 3 mm wrench and unlock the screw and the washer
- It is now possible to clear the counterweight shaft and proceed to the substitution of parts (shaft, knobs).
- Re-assemble and fasten the screw with the 3 mm wrench.

9. SPARE PARTS

For ordering, refer to the TORNOMECCANICA code indicated aside of each part.

SPARE PART NAME	TORNOMECCANICA CODE
wedge-brake	RS 13
Wedge pressing bush for 18 mm rope	RS 07
Wedge pressing bush for 20 mm rope	RS 07bis
Reeving roller	RS 18
Counterweight side spacer - bush	RS 24
Counterweight side spacer - shaft	RS 25
Reeving roller side spacer	RS 26
Plastic key for counterweight	RS 27
Shaft for counterweight	RS 23
Knob for counterweight with holes for key	RS 19
Knob for counterweight - set screw side	RS 22
Plastic cover for axles	RS 16

10. WARRANTY

SECURPULLEY® is warranted for 12 months from the purchasing date.

For the starting and validity of the warranty, reference is made to the date on the invoice or receipt, that must thus be kept and shown in case of request for repair under warranty.

The warranty includes the free of charge repair of SECURPULLEY® at TORNOMECCANICA or After Sales Centres.

The delivery expenses from/to the customer is at his charge

The warranty covers any manufacturing or assembling defect.

The warranty does not cover:

- damages due to improper storage, use, or setting
- damages due to non-observance of the directions of this booklet
- wear parts



SECURPULLEY®

TORNOMECCANICA s.r.l.

Genova - V. Renata Bianchi 67N. Tel. ++39 010 6509404 - Fax ++39 010 6509405

<http://www.securpulley.com> • info@securpulley.com